

M1250-T200L-0.5 (1550nm) Acousto-Optic Modulator



0419

APPLICATIONS

- Modulator
- Low Resolution Deflector
- Frequency Shifter

RF DRIVERS

Digital modulation	525C-2
Analog modulation	535C-2
Dual modulation	555F-2
Tuneable with modulation	630C-200 / iSPA-SF1-w

OUTLINE DRAWING

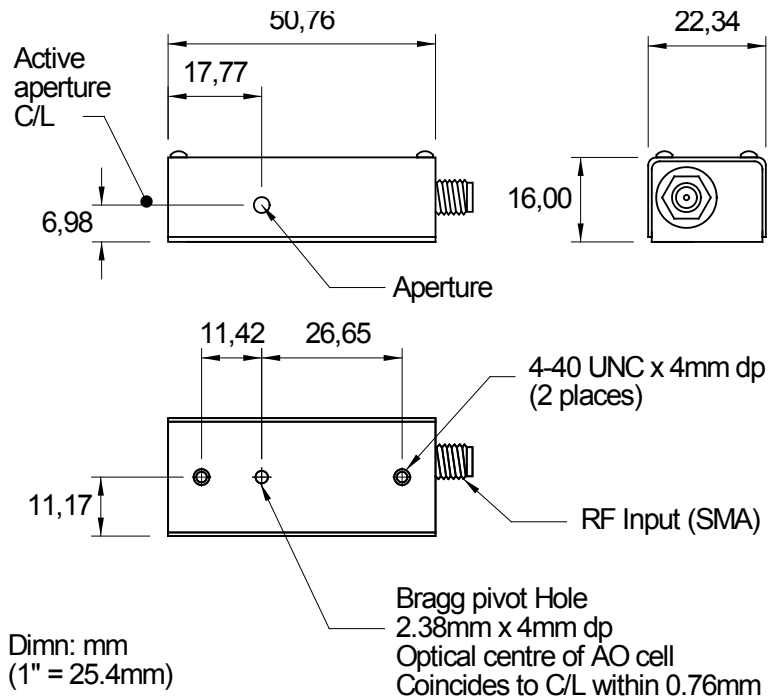

Option:

Metric fixing holes, M3-0.5 thread: add suffix -M

Mount device to heat conducting surface

ALL SPECIFICATIONS SUBJECT TO CHANGE WITHOUT NOTICE
 ISOMET CORP, 10342 Battlevue Parkway, Manassas, VA 20109, USA.
 Tel: (703) 321 8301 Fax: (703) 321 8546
 E-mail: ISOMET@ISOMET.COM Web Page: WWW.ISOMET.COM

Quality Assured.
 In-house: Crystal Growth,
 Optical Polishing,
 A/R coating, Vacuum Bonding

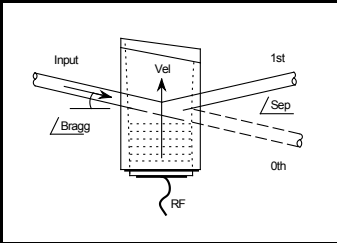

M1250-T200L-0.5 (1550nm)

Acousto-Optic Modulator



0419

SPECIFICATIONS

A/R Operating Wavelengths:	1550nm
Interaction Medium:	Tellurium Dioxide (TeO ₂)
Acoustic Velocity:	4.2mm/μs
Active Aperture:	0.5mm
Centre Frequency (CF):	200MHz
RF Bandwidth (minimum):	100MHz (+/- 50MHz)
Input Impedance:	50Ω Nominal
VSWR:	<1.5:1 @ 200MHz
DC Contrast Ratio:	>1000:1 min (>2000:1 typical)

CHARACTERISTICS at 1550nm

Active Aperture:	0.5mm
Peak RF Drive Power *:	9.0W
(Maximum average or CW power = 1.3W).	
Bragg angle:	36.9 mrad
Beam Separation:	73.8 mrad
Static Insertion Loss:	< 3%

PERFORMANCE vs. BEAM DIAMETER at 1550nm

Beam Diameter:	0.25mm	0.5mm
Rise Time:	39ns	77ns
Modulation Bandwidth @ MTF of 0.5:	8.7 MHz	5 MHz
Typical Deflection Efficiency at:		
10% of peak RF power:	>15%	>16%
25% of peak RF power:	>37%	>39%
50% of peak RF power:	>62%	>65%
75% of peak RF power:	>75%	>80%
100% of peak RF drive:	>80%	>85%

* Duty cycled operation, maximum average (or CW) RF power = 1.3W.

ALL SPECIFICATIONS SUBJECT TO CHANGE WITHOUT NOTICE
 ISOMET CORP, 10342 Battlevue Parkway, Manassas, VA 20109, USA.
 Tel: (703) 321 8301 Fax: (703) 321 8546
 E-mail: ISOMET@ISOMET.COM Web Page: WWW.ISOMET.COM

Quality Assured.
 In-house: Crystal Growth,
 Optical Polishing,
 A/R coating, Vacuum Bonding