

620A or 630A-3-110

RF Tuneable Driver

(Preliminary)



1213

The 620A/630A-110 is a modular VCO based frequency source specifically designed to operate with Isomet acousto-optic deflectors, modulators and frequency shifters. The driver generates an output frequency proportional to the input tuning voltage with a pseudo linear response between 0V and +10 volt. The driver also features a modulation input signal to control the amplitude of the RF output. The start frequency is adjustable and is set by the frequency offset potentiometer (FRQ OS). A secondary low level output signal is provided at the tuned operating frequency. This can be used for monitoring or feedback purposes. A Class-A power amplifier is integrated into the driver.

SPECIFICATIONS

Oscillator Type:	Varactor-tuned thin film hybrid
Amplifier Type:	Broadband Class A
Output RF Power:	≥ 3 Watt
Output Impedance:	50 Ω nominal
Load VSWR:	< 2.5:1 for best results
Frequency monitor output (FMON):	100mV pp, 50 ohm
RF Power Variation vs. Frequency:	≤ 1 dB
Spurious Outputs:	Harmonics > 20dB below fundamental
Tuning Range:	75 to 150MHz, maximum 85 to 135MHz, standard factory setting
Tuning Voltage (Vt):	0 to 10V for specified tuning range
Tuning Linearity:	<+/- 1.5% over specified tuning range
Tuning Voltage Impedance:	1 Kohm (nominal)
Tuning Slew Rate	> 10 MHz/ μ s
Residual FM:	< 10 KHz peak-to-peak
Frequency Stability:	$\pm 0.25\%$
Video Input Voltage (MOD):-	
(630C) Analogue option:	0-1V for 100% depth of modulation, DC coupled
(620C) Digital option:	TTL line driver compatible, positive logic
Input Impedance:	50 Ω source
RF On-Off Ratio:	> 40 dB
DC Power Input:	+24Vdc or +28Vdc at < 700 mA regulated to $\pm 0.25\%$
Temperature Range:	0°C to 50°C ambient Temperature at mounting face must not exceed 60°C
Mounting Orientation:	Any

ALL SPECIFICATIONS SUBJECT TO CHANGE WITHOUT NOTICE

ISOMET CORP, 5263 Port Royal Rd, Springfield, VA 22151, USA.

Tel: (703) 321 8301 Fax: (703) 321 8546

E-mail: ISOMET@ISOMET.COM Web Page: WWW.ISOMET.COM

Quality Assured.

In-house: RF & Digital design
Software Development
OEM manufacture

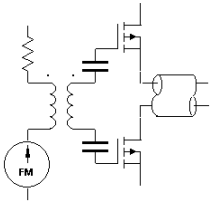

620A or 630A-3-110

RF Tuneable Driver

(Preliminary)



1213

OUTLINE DRAWING

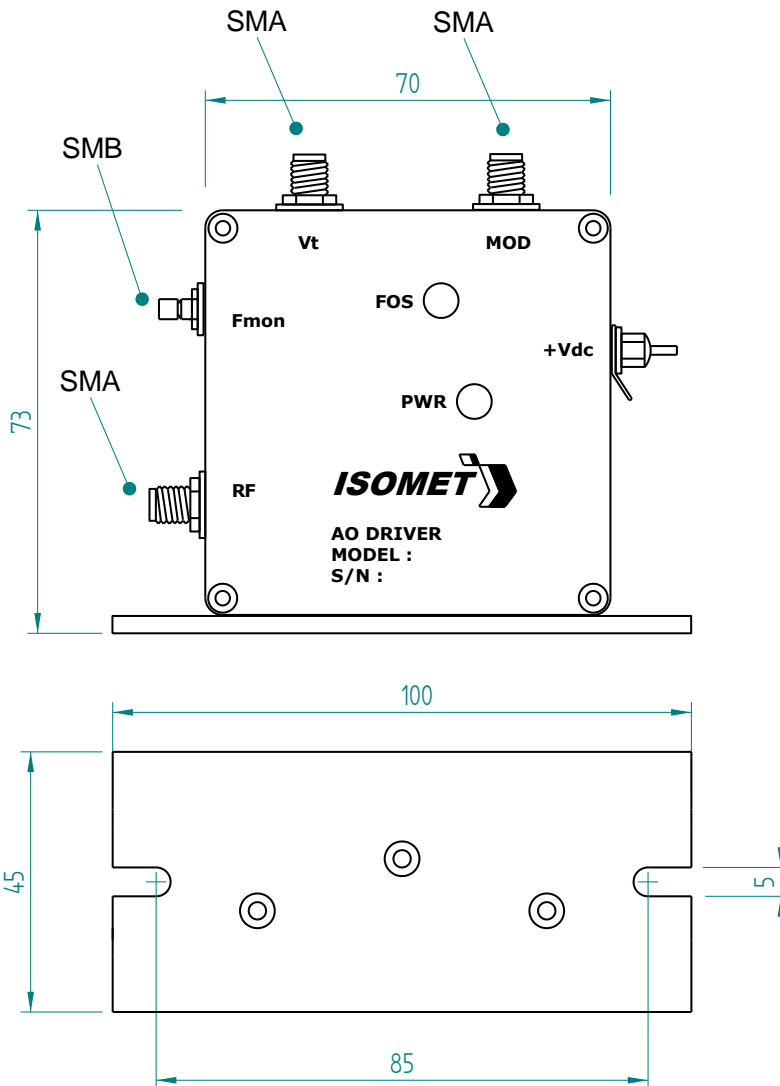

Dim'n: mm

ALL SPECIFICATIONS SUBJECT TO CHANGE WITHOUT NOTICE

ISOMET CORP, 5263 Port Royal Rd, Springfield, VA 22151, USA.

Tel: (703) 321 8301 Fax: (703) 321 8546

E-mail: ISOMET@ISOMET.COM Web Page: WWW.ISOMET.COM

Quality Assured.

In-house: RF & Digital design

Software Development

OEM manufacture